



Designation: E84 – 18b

An American National Standard

Standard Test Method for Surface Burning Characteristics of Building Materials¹

This standard is issued under the fixed designation E84; the number immediately following the designation indicates the year of original adoption or, in the case of revision, the year of last revision. A number in parentheses indicates the year of last reapproval. A superscript epsilon (ϵ) indicates an editorial change since the last revision or reapproval.

This standard has been approved for use by agencies of the U.S. Department of Defense.

1. Scope*

1.1 This fire-test–response standard for the comparative surface burning behavior of building materials is applicable to exposed surfaces such as walls and ceilings. The test is conducted with the specimen in the ceiling position with the surface to be evaluated exposed face down to the ignition source. The material, product, or assembly shall be capable of being mounted in the test position during the test. Thus, the specimen shall either be self-supporting by its own structural quality, held in place by added supports along the test surface, or secured from the back side.

1.2 The purpose of this test method is to determine the relative burning behavior of the material by observing the flame spread along the specimen. Flame spread and smoke developed index are reported. However, there is not necessarily a relationship between these two measurements.

1.3 The use of supporting materials on the underside of the test specimen has the ability to lower the flame spread index from those which might be obtained if the specimen could be tested without such support. These test results do not necessarily relate to indices obtained by testing materials without such support.

1.4 Testing of materials that melt, drip, or delaminate to such a degree that the continuity of the flame front is destroyed, results in low flame spread indices that do not relate directly to indices obtained by testing materials that remain in place.

1.5 The values stated in inch-pound units are to be regarded as standard. The values given in parentheses are mathematical conversions to SI units that are provided for information only and are not considered standard.

1.6 The text of this standard references notes and footnotes that provide explanatory information. These notes and footnotes, excluding those in tables and figures, shall not be considered as requirements of the standard.

1.7 *This standard is used to measure and describe the response of materials, products, or assemblies to heat and flame under controlled conditions, but does not by itself incorporate all factors required for fire-hazard or fire-risk assessment of the materials, products, or assemblies under actual fire conditions.*

1.8 *This standard does not purport to address all of the safety concerns, if any, associated with its use. It is the responsibility of the user of this standard to establish appropriate safety, health, and environmental practices and determine the applicability of regulatory limitations prior to use.*

1.9 *Fire testing is inherently hazardous. Adequate safeguards for personnel and property shall be employed in conducting these tests.*

1.10 *This international standard was developed in accordance with internationally recognized principles on standardization established in the Decision on Principles for the Development of International Standards, Guides and Recommendations issued by the World Trade Organization Technical Barriers to Trade (TBT) Committee.*

2. Referenced Documents

2.1 ASTM Standards:²

Specification for Zinc-Coated (Galvanized) Steel Poultry Fence Fabric (Hexagonal and Straight Line)

Specification for Flat Fiber-Cement Sheets

Specification for Fiber-Cement Interior Substrate Sheets

Specification for Gypsum Board

Test Methods for Direct Moisture Content Measurement of Wood and Wood-Based Materials

Test Method for Laboratory Standardization and Calibration of Hand-Held Moisture Meters

Test Method for Combustible Properties of Treated Wood by the Fire-Tube Apparatus

Test Method for Combustible Properties of Treated Wood by the Crib Test³

¹ This test method is under the jurisdiction of ASTM Committee E05 on Fire Standards and is the direct responsibility of Subcommittee E05.22 on Surface Burning.

Current edition approved Oct. 1, 2018, Published October 2018. Originally approved in 1950. Last previous edition approved in 2018 as E84 – 18a. DOI: 10.1520/E0084-18B.

² For referenced ASTM standards, visit the ASTM website, www.astm.org, or contact ASTM Customer Service at service@astm.org. For *Annual Book of ASTM Standards* volume information, refer to the standard's Document Summary page on the ASTM website.

*A Summary of Changes section appears at the end of this standard

Test Method for Surface Flammability of Materials Using a Radiant Heat Energy Source Terminology of Fire Standards

Test Method for Surface Flammability of Building Materials Using an 8-ft (2.44-m) Tunnel Furnace (Withdrawn 1991)³

Practice for Specimen Preparation and Mounting of Pipe and Duct Insulation Materials to Assess Surface Burning Characteristics

Practice for Specimen Preparation and Mounting of Textile, Paper or Polymeric (Including Vinyl) and Wood Wall or Ceiling Coverings, Facings and Veneers, to Assess Surface Burning Characteristics

Practice for Specimen Preparation and Mounting of Site-Fabricated Stretch Systems to Assess Surface Burning Characteristics

Practice for Specimen Preparation and Mounting of Wood Products to Assess Surface Burning Characteristics

Practice for Specimen Preparation and Mounting of Reflective Insulation, Radiant Barrier and Vinyl Stretch Ceiling Materials for Building Applications to Assess Surface Burning Characteristics

Practice for Specimen Preparation and Mounting of Tapes to Assess Surface Burning Characteristics

Practice for Specimen Preparation and Mounting of Caulks and Sealants to Assess Surface Burning Characteristics

Test Method for Extended Duration Surface Burning Characteristics of Building Materials (30 min Tunnel Test)

Practice for Specimen Preparation and Mounting of Flexible Fibrous Glass Insulation for Metal Buildings to Assess Surface Burning Characteristics

2.2 NFPA Standards:⁴

Standard Method of Test for Flame Travel and Smoke of Wires and Cables for Use in Air-Handling Spaces (2007)

2.3 UL Standards⁵

Standard for Safety for Fire Test of Pneumatic Tubing for Flame and Smoke Characteristics (2004)

Standard for Fire Test of Plastic Sprinkler Pipe for Visible Flame and Smoke Characteristics (2004)

Standard for Safety for Optical Fiber and Communication Cable Raceway (2004)

3. Terminology

3.1 Definitions:

3.1.1 For definitions of terms used in this test method refer to Terminology . The term flame spread index from Terminology is of particular interest to this standard and is defined in .

³ The last approved version of this historical standard is referenced on www.astm.org.

⁴ Available from National Fire Protection Association, 1 Battery March Park, Quincy, MA 02169.

⁵ Available from Underwriters Laboratories, 333 Pfingsten Road, Northbrook, IL 60062.

3.1.2 flame spread index, *n*—a number or classification indicating a comparative measure derived from observations made during the progress of the boundary of a zone of flame under defined test conditions.

3.2 Definitions of Terms Specific to This Standard:

3.2.1 smoke developed index, *n*—a number or classification indicating a comparative measure derived from smoke obscuration data collected during the test for surface burning characteristics.

3.2.2 surface flame spread, *n*—the propagation of a flame away from the source of ignition across the surface of the specimen.

4. Significance and Use

4.1 This test method is intended to provide only comparative measurements of surface flame spread and smoke density measurements with that of select grade red oak and fiber-cement board surfaces under the specific fire exposure conditions described herein.

4.2 This test method exposes a nominal 24-ft (7.32-m) long by 20-in. (508-mm) wide specimen to a controlled air flow and flaming fire exposure adjusted to spread the flame along the entire length of the select grade red oak specimen in 5½ min.

4.3 This test method does not provide for the following:

4.3.1 Measurement of heat transmission through the tested surface.

4.3.2 The effect of aggravated flame spread behavior of an assembly resulting from the proximity of combustible walls and ceilings.

4.3.3 Classifying or defining a material as noncombustible, by means of a flame spread index by itself.

5. Apparatus

5.1 Fire Test Chamber—See .

5.1.1 The fire test chamber is a rectangular horizontal duct with a removable lid. The inside dimensions are as follows:

Width:	17 ¾ ± ¼ in. (451 ± 6.3 mm) measured between the top ledges along the side walls, and 17 ⅝ ± ⅜ in. (448 ± 10 mm) at all other points.
Depth:	12 ± ½ in. (305 ± 13 mm) measured from the bottom of the test chamber to the top of the ledges on which the specimen is supported. This measurement includes the ⅜ in. (3.2 mm) thickness of the 1 ½ in. (38 mm) wide woven fiberglass gasket tape.
Length:	25 ft ± 3 in. (7.62 m ± 76 mm).

5.1.2 The sides and base of the chamber shall be lined with an insulating firebrick with the dimensions of 4 ½ in. by 9 in. by 2 ½ in. thick as illustrated in . The insulating firebrick shall have the following properties:

Maximum Recommended Temperature	2600°F (1427°C)
Bulk Density	48 ± 3 lb/ft ³ (0.77 ± 0.046 g/cm ³)
Thermal Conductivity at Mean Temperature of	Btu•in./h•ft ² •°F W/m•°C
500°F (260°C)	1.6 0.23
1000°F (538°C)	1.9 0.27
1500°F (815°C)	2.2 0.32
2000°F (1093°C)	2.6 0.37

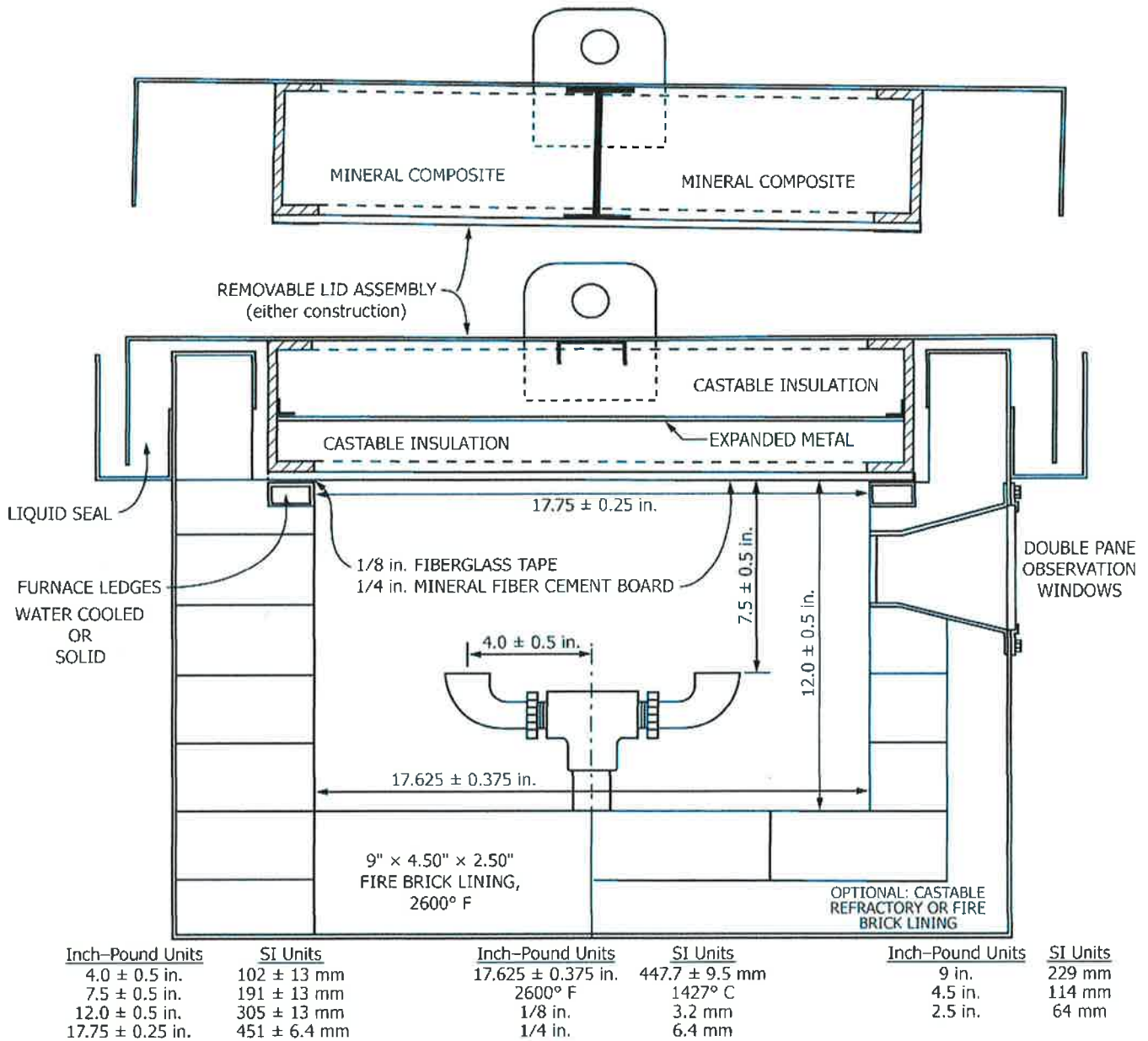

FIG. 2 Test Furnace Showing Critical Dimensions (Not a Construction Drawing)

5.1.6.2 The controls used to assure constant flow of gas to the burners during period of use shall consist of a pressure regulator, a gas meter constructed to read in increments of not more than 0.1 ft³ (2.8 L), a manometer to indicate gas pressure in inches of water, a quick-acting gas shut-off valve, and a gas metering valve.

5.1.7 Air Intake:

5.1.7.1 An air intake shutter shall be located 54 ± 5 in. (1372 ± 127 mm) upstream of the burner, as measured from the burner centerline to the outside surface of the shutter (see). The air intake is to be fitted with a vertically sliding shutter extending the entire width of the test chamber. The

shutter shall be positioned so as to provide an air inlet port 3 ± 1/16 in. (76 ± 2 mm) high measured from the floor level of the test chamber at the air intake point.

5.1.7.2 To provide air turbulence for proper combustion, turbulence baffling shall be provided by positioning six refractory firebricks (as defined in) along the side walls of the chamber. With the long dimension vertical, 4 1/2 in. (114-mm) dimension along the wall, place the bricks as follows from the centerline of the burner ports:

- On the window side at 7, 12, and 20 ± 1/2 ft (2.1, 3.7, and 6.1 ± 0.2 m)
- On the opposite side at 4 1/2, 9 1/2, and 16 ± 1/2 ft (1.3, 2.9, and 4.9 ± 0.2 m)

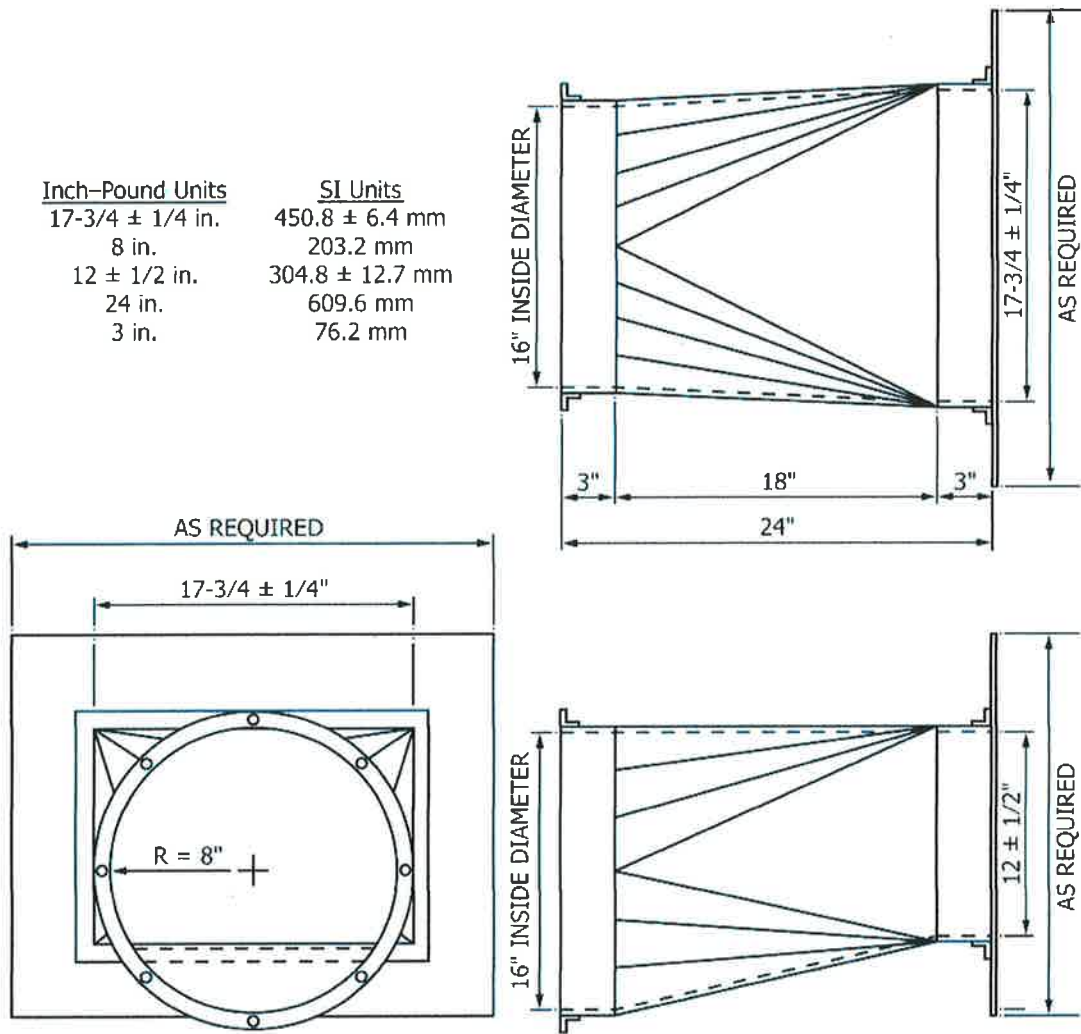

FIG. 3 Typical Exhaust End Transition (Not a Construction Drawing)

5.1.7.3 The movement of air shall be by an induced draft system having a total draft capacity of at least 0.15 in. (3.8 mm) water column with the sample in place, the shutter at the fire end open the normal $3 \pm \frac{1}{16}$ in. (76 ± 2 mm), and the damper in the wide open position. A draft gauge tap to indicate static pressure shall be inserted through the top at the midwidth of the tunnel, 1 ± 0.5 in. (25 ± 12 mm) below the ceiling, 15 ± 0.5 in. (381 ± 12 mm) downstream from the inlet shutter (see).

5.1.8 Exhaust End:

5.1.8.1 The other end of the test chamber is designated as the exhaust end. The exhaust end shall be fitted with a gradual rectangular-to-round transition piece, not less than 20 in. (508 mm) in length, with a cross-sectional area of not less than 200 in.² (1290 cm²) at any point (see).

5.1.8.2 The transition piece shall in turn be fitted to a 16 in. (406 mm) diameter duct pipe. A typical duct system shown in contains two 90° elbows (see) with the exhaust duct running beside the fire test chamber. In order to comply with this typical design, the vertical centerline of the exhaust duct system is identical to that of the fire test chamber.

5.1.8.3 The exhaust duct is to be insulated with at least 2 in. (51 mm) of high temperature mineral composition material from the exhaust end of the fire chamber to the photometer location.

5.1.8.4 An exhaust fan shall be installed at the end of the exhaust duct. The air flow shall be controlled as specified in

5.1.8.5 An alternative exhaust duct layout design shall demonstrate equivalency by meeting the requirements specified in Section .

5.1.9 Photometer System:

5.1.9.1 A photometer system consisting of a white light source and photocell⁸ shall be mounted on a horizontal section of the 16-in. (406-mm) diameter vent pipe at a point where it will be preceded by a straight run of pipe (at least 12 diameters

⁸ The sole source of supply of the apparatus known to the committee at this time is a model No. 856RRV from Huygen Corp., Crystal Lake, IL. If you are aware of alternative suppliers, please provide this information to ASTM Headquarters. Your comments will receive careful consideration at a meeting of the responsible technical committee,¹ which you may attend.

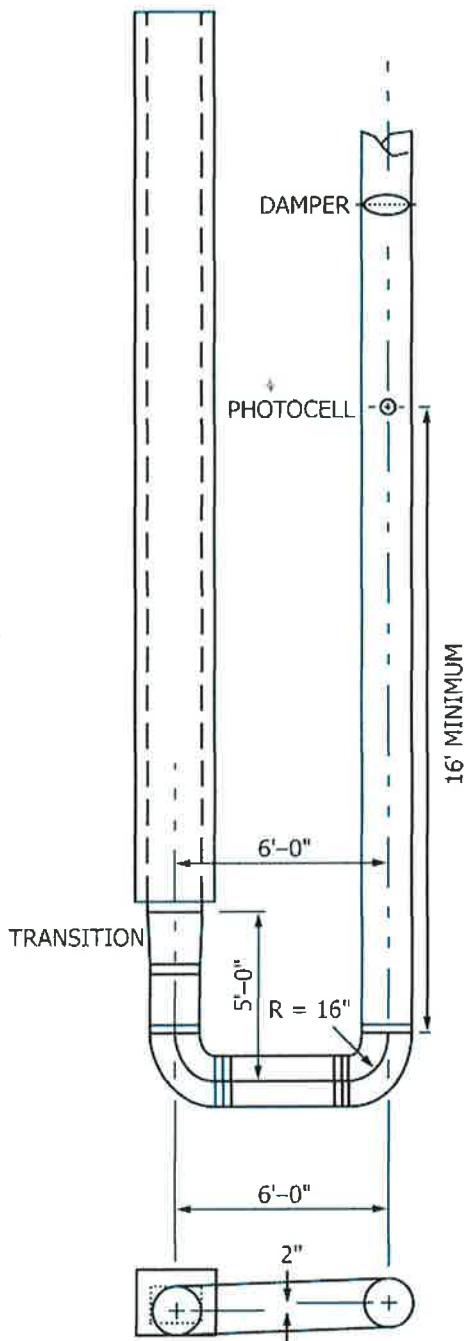

INCH-POUND UNITS	SI UNITS
16 in.	406.4 mm
2 in.	50.8 mm
5 ft.	1.52 m
6 ft.	1.83 m
16 - 40 ft.	4.88 - 12.2 m

FIG. 4 Plan View—Typical Duct System (Not a Construction Drawing)

vent pipe shall be insulated with at least 2 in. (51 mm) of high-temperature mineral composition material, from the vent end of the chamber to the photometer location. The output of the photoelectric cell is proportional to the smoke, particulate, and other effluent passing between the light source and photocell. The distance between the light source lens and the photocell lens shall be 36 ± 4 in. (914 ± 102 mm). The cylindrical light beam shall pass through 3-in. (76-mm) diameter openings at the top and bottom of the 16-in. diameter duct, with the resultant light beam centered on the photocell.

5.1.9.2 Linearity of the photometer system shall be verified periodically by interrupting the light beam with calibrated neutral density filters. The filters shall cover the full range of the recording instrument. Transmittance values measured by the photometer, using neutral density filters, shall be within $\pm 3\%$ of the calibrated value for each filter.

5.1.10 Draft Regulating Device:

5.1.10.1 An automatically controlled damper to regulate the draft pressure shall be installed in the vent pipe down-stream of the smoke-indicating attachment. The damper shall be provided with a manual override.

5.1.10.2 Other manual or automatic draft regulation devices, or both, are allowed to be incorporated to help maintain fan characterization and air-flow control throughout the test.

5.1.11 Thermocouples:

5.1.11.1 A No. 18 Awg (1.02-mm) thermocouple, with $\frac{3}{8} \pm \frac{1}{8}$ in. (9.5 ± 3.2 mm) of the junction exposed in the air, shall be inserted through the floor of the test chamber so that the tip is $1 \pm \frac{1}{32}$ in. (25.4 ± 0.8 mm) below the top surface of the gasketing tape and $23 \text{ ft} \pm \frac{1}{2}$ in. ($7.0 \text{ m} \pm 13$ mm) from the centerline of the burner ports at the center of its width.

5.1.11.2 Two No. 18 Awg (1.02 mm) thermocouples are embedded below the floor surface of the test chamber. These thermocouples shall be mounted at distances of $13 \text{ ft} \pm \frac{1}{2}$ in. ($3.96 \text{ m} \pm 13$ mm) and $23 \frac{1}{4} \text{ ft} \pm \frac{1}{2}$ in. ($7.09 \text{ m} \pm 13$ mm) measured from the centerline of the burner ports. The thermocouples shall be inserted from below the fire test chamber through the firebrick until the tip of the thermocouple is $\frac{1}{8} \pm \frac{1}{32}$ in. (3.2 ± 0.8 mm) below the floor surface. The tip of the thermocouples shall be covered with refractory or portland cement, carefully dried to avoid cracking.

6. Test Specimens

6.1 Specimens shall be representative of the materials which the test is intended to examine. The report shall include information on the composition needed for identification of the test specimen as described in .

6.2 The specimen shall be provided in one of two ways: (1) a continuous, unbroken length; (2) sections that will be joined or butted end-to-end.

- 6.3 The size of the test specimen shall be:
 - Width: between 20 and 24 in. (508 and 610 mm)
 - Length: $24 \text{ ft} + 12 \text{ in.} - 6 \text{ in.}$
 - Thickness: maximum 4 in. (101 mm).

NOTE 1—The test apparatus is not designed for testing at thicknesses greater than 4 in. (101 mm), but has the ability to be modified if required. This is accomplished through (a) modifications to the test apparatus lid to

or 16 ft (4.88 m) and not more than 30 diameters or 40 ft (12.19 m) from the vent end of the chamber, and with the light beam directed upward along the vertical axis of the vent pipe. The

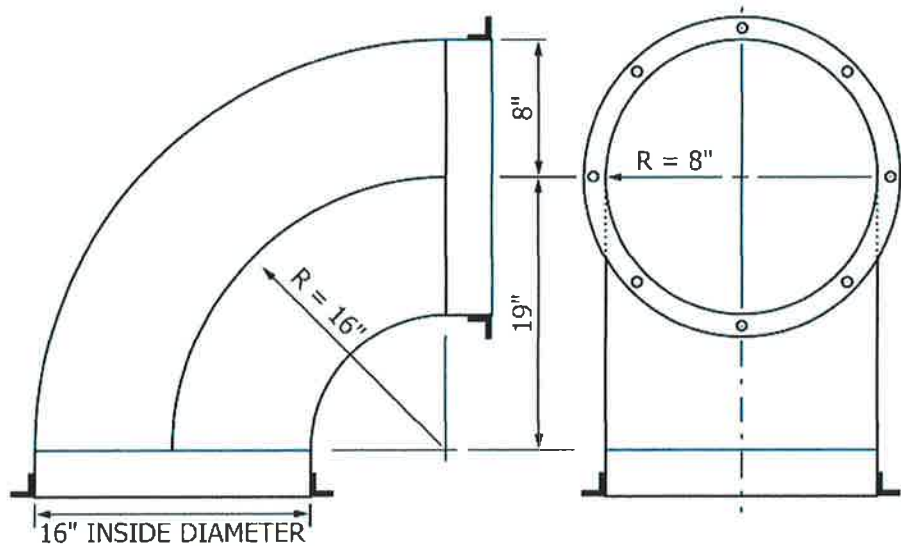

Inch-Pound Units	SI Units
16 in.	406.4 mm
8 in.	203.2 mm
19 in.	482.6 mm

FIG. 5 Typical Duct Elbow (Not a Construction Drawing)

maintain an airtight seal, and (b) the introduction, usually of additional sample/lid supports above the test apparatus ledges. Due to the composition of some materials, test results obtained at a thickness greater than 4 in. (101 mm) will potentially vary from results of a test on the same material tested at a thickness of 4 in. (101 mm) or less.

6.3.1 The test specimen shall be required to conform to the test specimen length and width described in unless the material complies with any one of the requirements in

NOTE 2—When tests are conducted with materials installed at less than full width, representing the end-use width, any resulting flame spread and smoke developed indices will not relate to indices obtained with the calibration material, which is tested using the specimen width described in

6.3.1.1 Materials for which there is a standard practice to address specimen preparation and mounting with this test method shall be tested as described in the appropriate standard practice (see).

6.3.1.2 Adhesives, tapes, and trim shall be permitted to be tested in the width or length, or both, specified in their listings, or as part of their conditions for being labeled, by a nationally recognized testing laboratory.

6.3.1.3 Materials and products for which there is a specific test method or application standard requiring the use of the apparatus described in Section shall be permitted to be tested in accordance with that specific test method or application standard (see).

6.4 The test specimen shall be conditioned to a constant weight at a temperature of $73.4 \pm 5^\circ\text{F}$ ($23 \pm 2.8^\circ\text{C}$) and at a relative humidity of $50 \pm 5\%$.

6.5 The upstream end of the fire test chamber shall be filled with a $14 \pm \frac{1}{8}$ —in. (356 ± 3 mm) length of uncoated

16-gauge (0.053 to 0.060 in.) steel plate positioned on the specimen mounting ledge in front of and under the leading edge of the specimen.

6.6 When the overall length of the test specimen exceeds 24 ft. (7.32 m), butt one end of the test specimen against the exhaust end of the fire test chamber and continue the installation of the specimen toward the gas burner.

6.7 When the overall length of the test specimen is 24 ft. (7.32 m) or less, provide a 1 in. (25 mm) overlap of the steel plate at the upstream end with one end of the test specimen and continue the installation of the specimen toward the exhaust end.

6.8 In addition to the above provisions, the standard practices listed below shall be used for specimen preparation, mounting and reporting of the relevant test materials. For all other products, guidance on mounting methods is provided in

for pipe and duct insulation materials.

for paper, polymeric (including vinyl and expanded vinyl) and textile wall and ceiling covering materials, facings or wood veneers intended to be applied on site over a wood substrate.

for site-fabricated stretch systems.

for the following wood products: solid board, lumber and timber products (including solid boards, lumber, timber, fingerjoined lumber, glulam, laminate wood, laminated veneer lumber and parallel strand lumber products), panel products (including fibreboard, hardboard, oriented strandboard, waferboard, and plywood panel products), decorative wood products (including fine woodwork, millwork and moulding) and shingles and shakes used as interior wall and

ceiling finish and interior trim as well as to laminated products factory-produced with a wood substrate.

for reflective insulation, radiant barrier and vinyl stretch ceiling materials for building applications.

for tapes up to and including 8 in. (203.2 mm) in width.

for any width of a caulk or sealant.

for flexible fibrous glass insulation for metal buildings.

7. Calibration

7.1 Place a nominal 1/4-in. (6.3-mm) fiber-cement board meeting the properties of on the ledge of the furnace chamber. Place the removable lid of the test chamber in position.

7.2 With the 1/4-in. (6.3-mm) fiber-cement board in position on top of the ledge of the furnace chamber and with the removable lid in place, establish a draft to produce a 0.15-in. (3.8-mm) water-column reading on the draft manometer, with the fire-end shutter open $3 \pm 1/16$ in. ($76 \pm$ mm), by manually setting the damper as a characterization of fan performance. Then close and seal the fire-end shutter, without changing the damper position. The manometer reading shall increase to at least 0.375 in. (9.53 mm), indicating that no excessive air leakage exists.

7.2.1 In addition, conduct a supplemental leakage test periodically with the tunnel sealed from the inlet end to beyond the photometer system, by placing a smoke bomb in the chamber. Ignite the bomb and pressurize the chamber to 0.375 ± 0.125 in. (9.53 ± 3.18 mm) water column. Seal all points of leakage observed in the form of escaping smoke particles.

7.3 Establish a draft reading within the range 0.055 to 0.100 in. (1.40 to 2.54 mm) water column. The required draft gauge reading will be maintained throughout the test by the automatically controlled damper. Record the air velocity at seven points, 23 ft from the centerline of the burner ports, $6 \pm 1/4$ in. (168 ± 7 mm) below the plane of the specimen mounting ledge. Determine these seven points by dividing the width of the tunnel into seven equal sections and recording the velocity at the geometrical center of each section. During the measurement of velocity, remove the turbulence bricks (see) and the exposed 23-ft thermocouple and place 24-in. (670-mm) long straightening vanes between 16 and 18 ft (4.88 and 5.49 m) from the burner. The straightening vanes shall divide the furnace cross section into nine uniform sections. Determine the velocity with furnace air temperature at $73.4 \pm 5^\circ\text{F}$ ($23 \pm 2.8^\circ\text{C}$), using a velocity transducer. The velocity, determined as the arithmetic average of the seven readings, shall be 240 ± 5 ft (73.2 ± 1.4 m)/min.

7.3.1 The following alternative to the velocity transducer equipment and method of determining the tunnel air velocity has been found suitable: A 4-in.-diameter low-speed rotary vane anemometer, having a resolution of 1 ft./min. with an accuracy of $\pm 2\%$, is attached to the steel stand and placed in the tunnel 22.5 ft downstream of the burners. Three trials shall be conducted and their values averaged. The average is rounded to the nearest unit. The centerline of the vane anemometer shall be aligned with the vertical centerline of the tunnel by placing

it on the steel stand. Trial 1 is run with the vane edge 1 in. from the non-window wall; Trial 2 is with the center axis at the tunnel center point; and Trial 3 is run with the vane edge 1 in. from the window wall.

7.4 The room in which the test chamber is located shall have provision for a free inflow of air during test to maintain the room at atmospheric pressure during the entire test run. Maintain the air supply at a temperature of 65–80°F (18.3–26.7°C) and a relative humidity of 45–60 %.

7.5 Supply the fire test chamber with natural (city) or methane (bottled) gas fuel of uniform quality with a heating value of nominally 1000 Btu/ft³ (37.3 MJ/m³). Adjust the gas supply initially at approximately 5000 Btu (5.3 MJ)/min. Record the gas pressure, the pressure differential across the orifice plate, and the volume of gas used in each test. If a temperature- and pressure-compensating mass flowmeter is utilized, record only the volume of gas used. Unless otherwise corrected for, when bottled methane is employed, insert a length of coiled copper tubing into the gas line between the supply and metering connection to compensate for possible errors in the flow indicated due to reductions in gas temperature associated with the pressure drop and expansion across the regulator. With the draft and gas supply adjusted as indicated in and , the test flame shall extend downstream to a distance of 4½ ft (1.37 m) over the specimen surface, with negligible upstream coverage.

7.6 Preheat the test chamber with the 1/4-in. (6.3-mm) fiber-cement board and the removable lid in place and with the fuel supply adjusted to the required flow. Continue the preheating until the temperature indicated by the floor thermocouple at 23¼ ft (7.09 m) reaches $150 \pm 5^\circ\text{F}$ ($66 \pm 2.8^\circ\text{C}$). During the preheat test, record the temperatures indicated by the thermocouple at the vent end of the test chamber at intervals not longer than 15 s.

7.6.1 Compare the temperature readings during the preheat test in with those in the time-temperature curve in . If they are different investigate the differences and make adjustments as necessary, while maintaining calibration requirements.

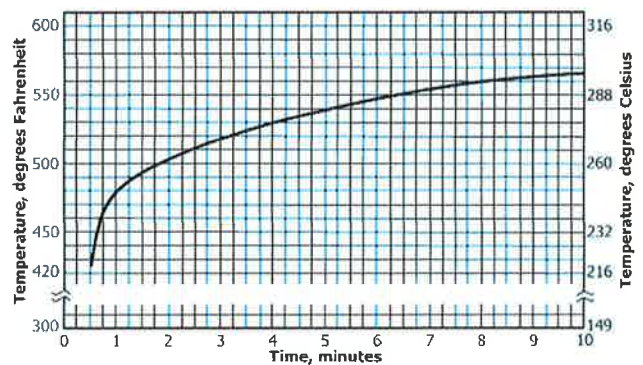

FIG. 6 Representative Time-Temperature Curve for Preheat Temperatures

7.7 Allow the furnace to cool after each test. When the floor thermocouple at 13 ft (3.96 m) shows a temperature of $105 \pm 5^\circ\text{F}$ ($40.5 \pm 2.8^\circ\text{C}$), place the next specimen in position for test.

7.8 With the test equipment adjusted and conditioned as described in , , , and , make a test or series of tests, using nominal $2\frac{3}{32}$ -in. (18-mm) select-grade red oak flooring samples and samples of $\frac{1}{4}$ -in. (6-mm) fiber-cement board. Conduct these tests in either order.

7.8.1 The red oak decks are to be constructed and conditioned as specified in Annex A1 and Annex A2. Make observations at distance intervals not in excess of 2 ft (0.6 m) and time intervals not in excess of 30 s, and record the time when the flame reaches the end of the specimen $19\frac{1}{2}$ ft (5.94 m) from the end of the ignition fire. The end of the ignition fire shall be considered as being $4\frac{1}{2}$ ft (1.4 m) from the burners. The flame shall reach the end point in $5\frac{1}{2}$ min \pm 15 s. Automatically record the temperature measured by the exposed thermocouple at 23 ft. (7.0 m) at least every 15 s. Automatically record the photoelectric cell output immediately prior to the test and at least every 15 s during the test.

7.8.2 Another means of judging when the flame has reached the end point is when the exposed thermocouple at 23 ft (7.0 m) registers a temperature of 980°F (527°C).

7.9 Plot the flame spread distance, temperature, and change in photoelectric cell readings for the duration of the test.

are representative curves for red oak flame spread distance, time-temperature development, and smoke density, respectively. Flame spread distance shall be determined as the observed distance minus $4\frac{1}{2}$ ft (1.37 m).

7.10 Conduct a similar test or tests on samples of $\frac{1}{4}$ -in. (6-mm) fiber-cement board. These results shall be considered as representing an index of 0. Plot the temperature readings for the duration of the test. is a representative curve for time-temperature development for fiber-cement board.

7.11 The calibrations described in Section shall be performed after major repairs, such as re-bricking, have been made. If there have been no major repairs, new calibrations

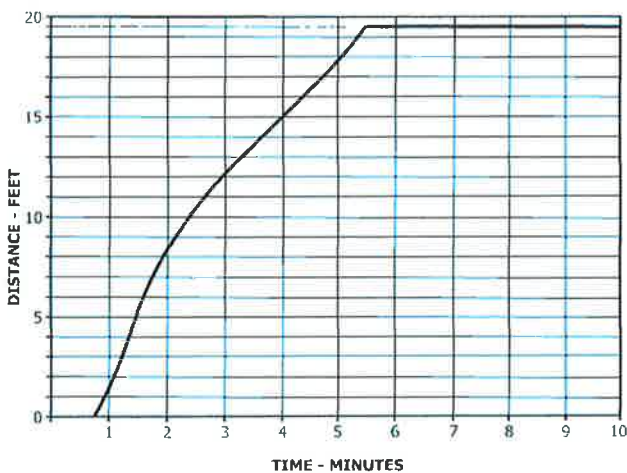

FIG. 7 Representative Time-Distance Curve for Flame Spread of Red Oak

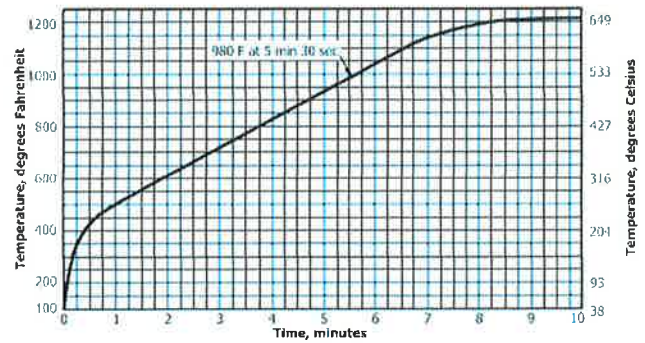

FIG. 8 Representative Time-Temperature Curve for Red Oak

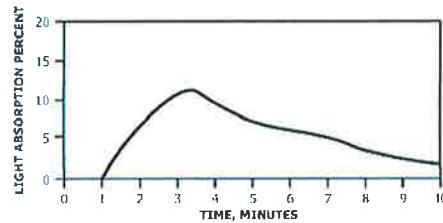

FIG. 9 Representative Time-Absorption Curve for Smoke Density of Red Oak

shall be conducted after 200 tests, or every 12 months, whichever comes first.

7.12 The red oak flame spread calibration data shall be used to confirm performance indicated in , that the flame reaches the end of the specimen at a time no less than 5 min 15 s and no more than 5 min 45 s from the start of the test. In the event that the flame reaches the end of the specimen outside these time limits, make adjustments and recalibrate until the correct time is achieved.

7.13 Add the data from the new red oak smoke calibration to a data set containing the last four calibrations in order to maintain a running average of at least five calibrations. This average of smoke-developed index (SDI) data shall provide the calibration data to be used to adjust the settings for the equipment and to establish areas for calculation of the SDI. When fewer than five calibrations have been performed on new equipment, average the available number of calibrations to achieve the running average.

8. Procedure

8.1 With the furnace draft operating, place the test specimen on the test chamber ledges that have been completely covered with nominal $\frac{1}{8}$ -in. (3.2-mm) thick by $1\frac{1}{2}$ -in. (38-mm) wide woven gasketing tape. Place the specimen as quickly as is practical. Place the removable top in position over the specimen.

8.2 Keep the completely mounted specimen in position in the chamber with the furnace draft operating for 120 ± 15 s prior to the application of the test flame.

8.3 Ignite the burner gas. Observe and record the distance and time of maximum flame front travel with the room darkened. Continue the test for a 10-min period. Termination of

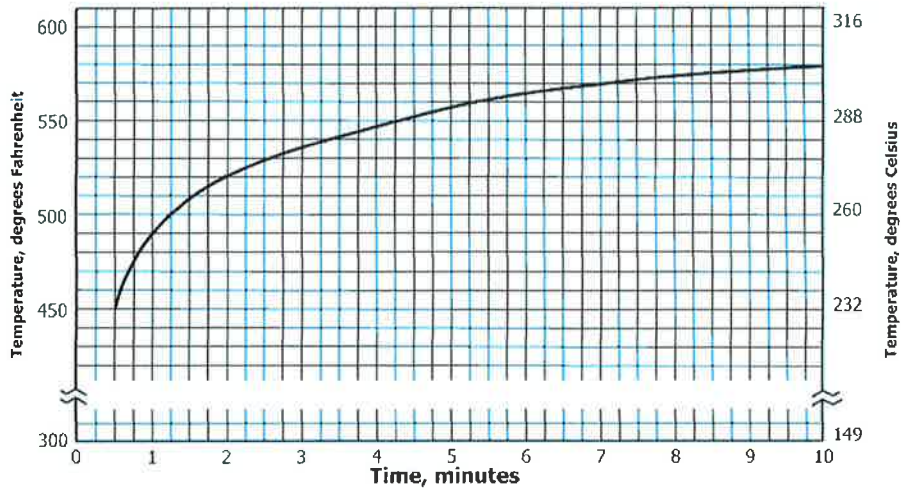

FIG. 10 Representative Time-Temperature Curve for Fuel Contribution of Fiber-Cement Board

the test prior to 10 min is permitted if the specimen is completely consumed in the fire area and no further progressive burning is evident and the photoelectric cell reading has returned to the baseline.

8.4 Record the photoelectric cell output immediately prior to the test and at least every 2 s during the test.

8.5 Record the gas pressure, the pressure differential across the orifice plate, and the volume of gas used in each test. If a temperature- and pressure-compensating mass flowmeter device is used to monitor the gas flow, record only the volume of gas.

8.6 When the test is ended, shut off the gas supply, observe smoldering and other conditions within the test duct, and remove the specimen for further examination.

8.7 Plot the flame spread distance, temperature, and change in photoelectric cell readings for the duration of the test for use in determining the flame-spread and smoke-developed indexes

as outlined in Section 9. Flame front advancement shall be recorded at the time of occurrence or at least every 30 s if no advancement is noted. Flame spread distance shall be determined as the observed distance minus 4½ ft (1.37 m).

9. Interpretation of Results

9.1 The flame spread index (FSI) shall be the value, determined as follows, rounded to the nearest multiple of five.

9.1.1 describes the derivation of the formulas for the flame spread area values needed for the FSI.

9.1.2 In plotting the flame spread distance-time relationship, all progressive flaming as previously recorded shall be included at the time of occurrence. A straight line shall be used to connect successive points. The total area (A_T) under the flame spread distance-time plot shall be determined by ignoring any flame front recession. For example, in the flame spreads 10 ft (3.05 m) in 2½ min and then recedes. The area is calculated as if the flame had spread to 10 ft in 2½ min and

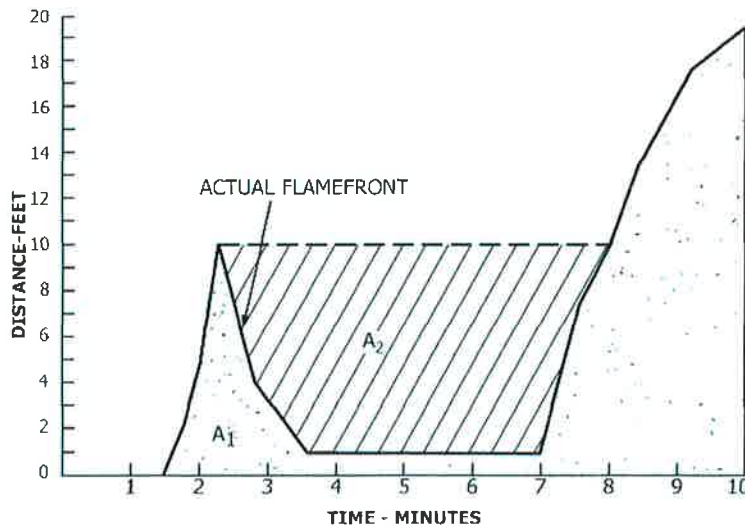

FIG. 11 Example of Time-Distance Relationship with Flame Front Recession (Total Area, $A_T = A_1 + A_2$)

then remained at 10 ft for the remainder of the test or until the flame front again passed 10 ft. This is shown by the dashed line in . The area (A_T) used for calculating the flame spread index is the sum of areas A_1 and A_2 in .

9.1.3 If this total area (A_T) is less than or equal to 97.5 ft-min, the flame spread index shall be 0.515 times the total area ($FSI = 0.515 A_T$).

9.1.4 If the total area (A_T) is greater than 97.5 ft-min, the flame spread index shall be 4900, divided by the difference of 195 minus the total area (A_T). ($FSI = 4900/(195 - A_T)$).

9.2 The test results for smoke shall be plotted and the area under the curve shall be divided by the area under the curve for red oak, multiplied by 100, and rounded to the nearest multiple of five to establish a numerical smoke-developed index (SDI). The performance of the material is compared with that of fiber-cement board and select grade red oak flooring, which have been arbitrarily established as 0 and 100, respectively. For smoke-developed indexes 200 or more, the calculated value shall be rounded to the nearest 50 points.

9.2.1 There are no formulas to derive SDI, which is calculated as indicated above.

10. Analysis of Products of Combustion

10.1 Samples for combustion product analysis, when analysis is requested, shall be taken downstream from the photometer, or shall consist of not more than 1 % of the total flow. Analysis of the products of combustion is not required in this test method.

11. Report

11.1 Report the following information:

11.1.1 Description of the material being tested, including its composition or generic identification, thickness, and any relevant additional details,

11.1.2 Test results as calculated in Section ,

11.1.3 Details of the method used in placing the specimen in the chamber, to include the following:

11.1.3.1 A statement whether a continuous or sectioned specimen is used,

11.1.3.2 A description of the number of sections and their sizes, when the specimen consists of sections joined end-to-end,

11.1.3.3 The mounting method employed, including additional information required to be reported by the applicable specimen preparation and mounting practice referenced in .

11.1.3.4 The width and length of the specimen tested (See also), and

11.1.3.5 The method of placement of the cement board protecting the furnace lid assembly.

11.1.4 Observations of the burning characteristics of the specimen during test exposure, such as delamination, sagging, shrinkage, fallout, etc., and

11.1.5 Graphical plots of flame spread and smoke developed data.

12. Precision and Bias⁹

12.1 *Precision*—A series of interlaboratory tests for this test method was run using eleven laboratories and six materials. Four replicates of each material were tested. The complete results have been placed on file at ASTM Headquarters as a Research Project entitled “Interlaboratory Test Study on ASTM E84, Standard Test Method for Surface Burning Characteristics of Building Materials.” Data was calculated in accordance with Practice 1 and ISO 5725.

12.2 Even though Test Method E84 provides measurement of a Flame Spread Index and a Smoke Developed Index, only the Flame Spread Index is considered in this precision statement because the test series utilized a smoke measurement system that was a variation from that described in the test method. Data on precision of the smoke developed index is being worked on by Task Group No. 1 of Subcommittee E5.22 and will be included in a future revision of this test method.

12.3 Within-laboratory (repeatability) data is given in

12.4 Between-laboratory (reproducibility) data is given in

12.5 *Bias*—No information is presented on the bias of the procedure in this test method because correct values for fire-test-response characteristics of building materials can only be defined in terms of a test method. Within this limitation, this test method has no known bias and can be accepted as a reference method.

13. Keywords

13.1 flame spread; flame spread index; smoke developed; smoke developed index; Steiner tunnel; surface burning characteristics; 25 ft tunnel; tunnel test

⁹ Supporting data have been filed at ASTM Headquarters and may be obtained by requesting ISR E05-0001.

TABLE 1 Within-Laboratory (Repeatability) Precision Data

Material	Parameter—Flame Spread Index		
	Mean Value	Repeatability Standard Deviation, S_r	Relative Standard Deviation, %
Douglas Fir Plywood	91	15	16
Fire Retardant Treated Douglas Fir Plywood	17	3	17
Type X Gypsum Board	9	2	19
Rigid Polystyrene Foam	7	1	18
Rigid Polyurethane Foam	24	3	13
Composite Panel	17	2	12

TABLE 2 Between-Laboratory (Reproducibility) Precision Data

Material	Parameter—Flame Spread Index		
	Mean Value	Reproducibility Standard Deviation, S_R	Relative Standard Deviation, %
Douglas Fir Plywood	91	23	25
Fire Retardant Treated Douglas Fir Plywood	17	6	33
Type X Gypsum Board	9	3	36
Rigid Polystyrene Foam	7	4	60
Rigid Polyurethane Foam	24	5	23
Composite Panel	17	4	21

ANNEXES

(Mandatory Information)

A1. CONSTRUCTION GUIDELINES OF RED OAK DECKS

A1.1 Introduction

A1.1.1 General construction outline of the red oak decks is shown in

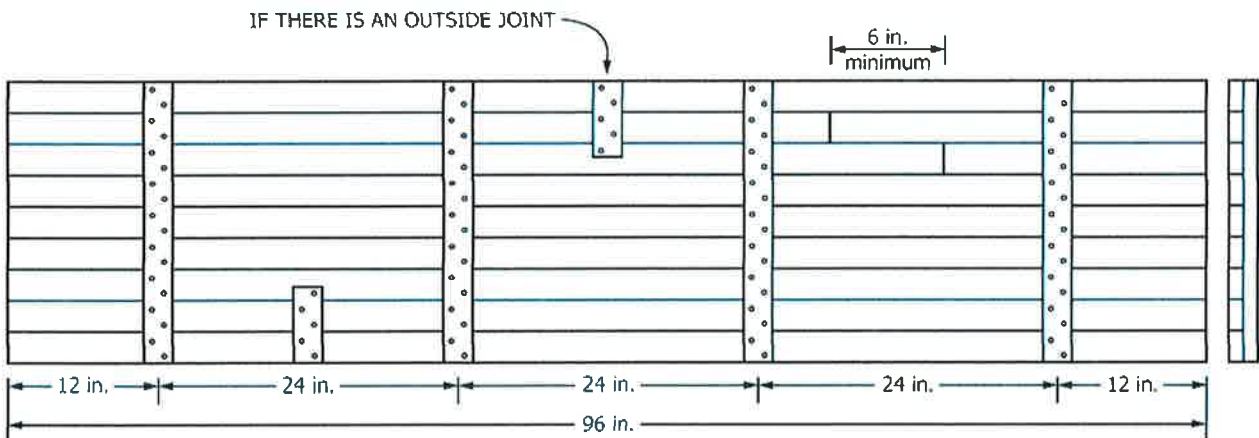

- Use 9 rows of red oak per deck.
- Batten strips are nominal 1 in. by 2 in. or 1 in. by 3 in.
- Use 4d cement coated nails or equivalent, two per red oak strip per batten.
- For outside edges, use longest red oak strips available. If shorter than 96 in., use 6 in. long batten strips.
- Do not use red oak strips less than 24 in. long on outside edge.
- Allow 6 in. minimum distance between other joints on adjacent red oak strips.
- While nailing, use cabinet clamps or other suitable means to ensure there are no cracks or gaps between the red oak strips in the deck surface.

<u>Inch-Pounds Units</u>	<u>SI Units</u>
1 in.	25.4 mm
2 in.	50.8 mm
6 in.	152.4 mm
12 in.	304.8 mm
24 in.	609.6 mm
96 in.	2.44 m

FIG. A1.1 Red Oak Calibration Deck Construction

A2. PROCEDURE FOR DETERMINING MOISTURE CONTENT IN RED OAK

A2.1 Introduction

A2.1.1 Oven Dry Method:

A2.1.1.1 This procedure shall be used for the determination of moisture content of the select-grade red oak calibration material using an oven-dry method. From trimmed sections of the calibration decks, prepare a minimum of six specimens $4 + \frac{1}{16} - 0$ inches ($100 + 2 - 0$ mm) long. The specimens shall be free from visible irregularities of knots, decay, reaction wood, and resin concentration. Place the trimmed sections adjacent to the calibration decks in a conditioning atmosphere that will result in an average moisture content of 7 ± 0.5 %. Using either a conductance or dielectric-type meter (calibrated per Test Methods for red oak species), monitor moisture content until the desired level is reached. Subject the trimmed sections only to the secondary oven-drying method (Method B) in Test Methods for the final determination of moisture content.

A2.1.2 Moisture Meter Method:

A2.1.2.1 This procedure shall be used for the determination of moisture content of the select-grade red oak calibration material using a moisture meter method. Place the calibration decks in a conditioning atmosphere that will result in an average moisture content of 7 ± 0.5 %. Using either a conductance or dielectric type meter (calibrated per Test Methods for red oak species), monitor moisture content until the desired level is reached. The final determination of average moisture content of the test sample is to be determined as follows. Take 10 readings on each of the three red oak decks such that a representative sampling is obtained over the entire area of the deck. The moisture content of the test sample shall be an arithmetic average of the 30 readings.

A3. FIBER-CEMENT BOARD REQUIREMENTS

A3.1 Use of Fiber-Cement Board:

A3.1.1 Fiber cement is used in this test method as a calibration material and, in some instances, as a backing material,

A3.1.2 Whenever fiber-cement board is specified in this test method, the material shall meet the requirements in .

A3.2 Fiber-Cement Board Requirements:

A3.2.1 The fiber-cement board shall comply with Specification or , Grade II, and the following additional properties:

A3.2.1.1 Nominal thickness shall be $\frac{1}{4}$ in. (6.3 mm).

A3.2.1.2 Density = 90 ± 10 lb/ft³ (1444 ± 160 kg/m³).

A3.2.1.3 The board shall be uncoated.

A3.2.1.4 The board shall stay in-place during a 10-min. test.

A3.2.1.5 The board shall be suitable for test sample adhesion.

A4. USE OF METAL SUPPORT PIECES

A4.1 Metal support pieces shall not be used unless needed to prevent the test specimen from sagging and interfering with the progression of the flame front.

A4.2 When metal support pieces are used, the requirements within these annex sections apply, unless otherwise specified in this test method or in a standard practice referenced in this test method (see also).

A4.3 The use of rods, bars, netting, rods and netting, or bars and netting, is intended only as support of test specimens that are not self-supporting.

A4.4 Rods or bars shall be used without netting unless that use leads to the test specimen sagging and interfering with the progression of the flame front.

A4.5 *Netting*—Whenever netting is used as a support in this test method, the material shall be 20-gauge, 2-in. (51-mm) hexagonal galvanized steel netting conforming to Specification

A4.6 *Rods*—Whenever metal rods are used as support in this test method, they shall be steel rods $\frac{1}{4}$ in. (6.3 mm) in diameter and shall span the width of the tunnel.

A4.7 *Bars*—Whenever metal bars are used as support in this test method, they shall be steel bars $\frac{3}{16}$ in. by 2 in. (5 mm by 51 mm) and shall span the width of the tunnel. Bars shall not be used instead of rods unless they are required to prevent the test specimen from sagging and interfering with the progression of the flame front.

A4.8 *Placement of Metal Rods*—Rods shall be placed at intervals of approximately 24 in. (610 mm), on center, along the length of the test specimen, starting at approximately 2 in. (51 mm) from the fire end of the test specimen.

A4.8.1 If 24 in. (610 mm) intervals between rods are too long for a certain test specimen, the interval to be used shall be the longest interval that prevents the test specimen from sagging and interfering with the progression of the flame front. If the distance between rods needed to prevent sagging is less

than 20 in. (508 mm) the rods shall be placed at 24 in. (610 mm) separation, with netting.

A4.9 *Placement of Metal Bars*—Bars shall be placed at intervals of approximately 24 in. (610 mm), on center, between the edges of the bars, along the length of the test specimen, starting at approximately 2 in. (51 mm) from the fire end of the test specimen.

A4.9.1 If 24 in. (610 mm) intervals between bars are too long for a certain test specimen, the interval to be used shall be the longest interval that prevents the test specimen from sagging and interfering with the progression of the flame front. If the distance between bars needed to prevent sagging is less than 20 in. (508 mm) the bars shall be placed at 24 in. (610 mm) separation, with netting.

A5. INSULATION FACINGS

A5.1 When insulation facings are tested on their own, they shall be tested supported on galvanized steel netting placed on steel rods in accordance with . Netting shall be 20-gauge, 2-in. (51-mm) hexagonal galvanized steel netting conforming to Specification .

A5.2 Section shall not supersede the requirements of any applicable mounting practices, such as Practices , or .

A6. MOUNTING METHOD FOR TESTING TEXTILE MATERIALS TO ASSESS SURFACE BURNING CHARACTERISTICS OF THE MATERIAL ITSELF WITH TEST METHOD E84

A6.1 When textile materials intended for application to walls or ceilings are tested to assess surface burning characteristics, see Practice .

A6.2 *Textile Materials with a Back Coating*—When the surface burning characteristics of the textile material itself are required, specimens shall be mounted on fiber-cement board adhered with high temperature bonding mortar. For textile materials that have a back coating, the adhesive shall be applied only to the back of the textile material using a $\frac{3}{32}$ -in. (2.4-mm) V-notched trowel held at an 80 to 90° angle and using a random pattern. The textile material specimen shall then be placed on the smooth side of the fiber-cement board, smoothed with a flat 12-in. (305-mm) brush with 1-in. (25.4-mm) nylon bristles, taking care not to force the adhesive into the specimen, or to stretch or physically deform the specimen, and rolled using a roller comprised of three 2.25-in. (57.2-mm) sections, a nominal diameter of 1.5-in. (38.1-mm), and a total length of 7- $\frac{3}{8}$ in. (187.3 mm). The roller shall have a nominal downward force of 20 lb (89 N) during use. It is acceptable for the prepared samples to be dead-stacked overnight but they shall be transferred to separate storage racks until tested. Each sample shall be vacuumed prior to test.

A6.3 *Textile Materials without a Back Coating*—When the surface burning characteristics of the textile material itself are required, specimens shall be mounted on fiber-cement board adhered with high temperature bonding mortar. For textile materials that do not have a back coating, the adhesive shall be applied to the smooth side of the fiber-cement board using a $\frac{3}{32}$ -in. (2.4-mm) V-notched trowel held at an 80 to 90° angle and using a random pattern. The textile material specimen shall then be placed into the wet adhesive, smoothed with a flat 12-in. (305-mm) brush with 1-in. (25.4-mm) nylon bristles, taking care not to force the adhesive into the specimen, or to stretch or physically deform the specimen, and rolled using a roller comprised of three 2.25-in. (57.2-mm) sections, a nominal diameter of 1.5-in. (38.1-mm), and a total length of 7- $\frac{3}{8}$ in. (187.3 mm). The roller shall have a nominal downward force of 20 lb (89 N) during use. It is acceptable for the prepared samples to be dead-stacked overnight but they shall be transferred to separate storage racks until tested. Each sample shall be vacuumed prior to test.

A6.4 In the event that the textile material cannot be adhered to the fiber-cement board using high temperature bonding mortar, use a two-part epoxy adhesive. The adhesive shall be

applied using a 3/32-in. (2.4-mm) V-notched trowel held at an 80 to 90° angle using a random pattern. If, due to the physical nature of the textile material, the use of the notched trowel is not appropriate, apply the epoxy adhesive using a 3/8-in. (9.5-mm) napped paint roller.

A6.5 Limitations

A6.5.1 In some instances, due to the porosity or density of some materials, application of the adhesive using the notched trowel will force the adhesive into and through the specimen causing “bleed through.” In such instances, the flame spread index and smoke developed index obtained would not neces-

sarily relate to the corresponding indices obtained by testing without such influence.

A6.5.2 In some other instances, due to the mechanical action of the trowel, severe stretching or physical deformation of some materials will occur, an occurrence especially prevalent with some knitted products. Deformation of a specimen results in a different areal weight and density, and thereby influences the fuel load contributed by the specimen. In such instances, the flame spread index and smoke developed index obtained would not necessarily relate to the corresponding indices obtained by testing without such influence.

A7. BATT OR BLANKET-TYPE INSULATING MATERIALS

A7.1 Batt or blanket materials that do not have sufficient rigidity or strength to support themselves shall be supported by metal rods inserted through the material and positioned such that the bottom of the rod is approximately 1/4 in. (6.3 mm) from the surface to be exposed to the flame.

A7.2 This mounting method shall not be used for batt or blanket materials less than 1 in. (25.4 mm) thick.

A8. ACOUSTICAL AND OTHER SIMILAR PANEL PRODUCTS LESS THAN 20 in. (508 mm)

A8.1 For acoustical materials and other similar panel products with a maximum dimension of less than 20 in. (508 mm), mount the products at full width in the tunnel (see 4.1.1) using metal splines or wood furring strips and metal fasteners.

A8.2 Steel tee splines for mounting kerfed-acoustical tile shall be nominal 1/2-in. (13-mm) web by 3/4-in. (19-mm) flange, formed No. 24 MS gauge sheet metal.

A8.3 Wood furring frames for mounting acoustical materials and other similar panel products less than 20 in. (508 mm) shall be nominal 1 by 2-in. (20 by 41-mm) wood furring joined with corrugated-metal fasteners. Use two frames as shown in

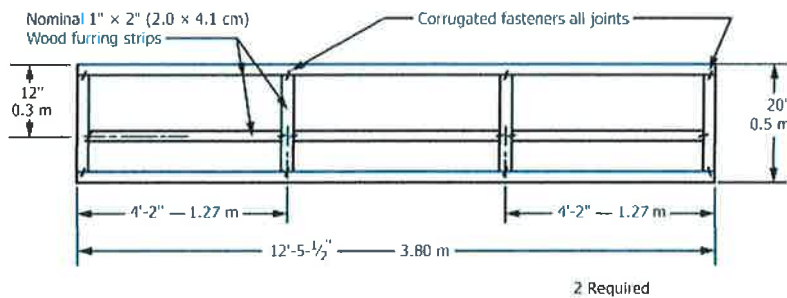

FIG. A8.1 Wood Frame for Acoustical Materials and Other Similar Panel Products Less Than 20 in. (508 mm)

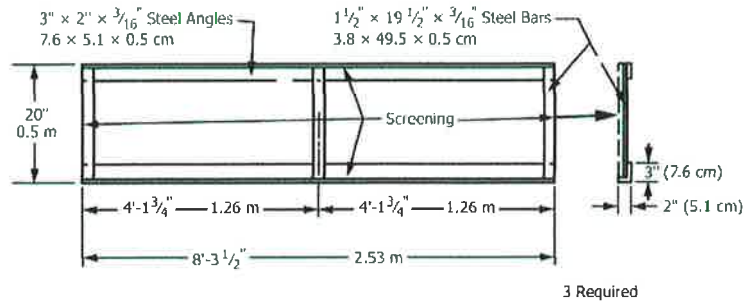

FIG. A10.1 Steel Frame for Loose Fill Insulation

APPENDIXES

(Nonmandatory Information)

X1. GUIDE TO MOUNTING METHODS

X1.1 Introduction

X1.1.1 Discussion:

X1.1.1.1 This guide has been compiled as an aid in selecting a method for specimen preparation and mounting of various building materials in the fire test chamber. These mountings are suggested for test method uniformity and convenience; they are not meant to imply restriction in the specific details of field installation. For some materials (see 6.8), specific specimen preparation and mounting methods have been developed, which shall be used for those materials.

X1.1.1.2 For some building materials none of the methods described in 6.8 or in this guide may be applicable. In such cases, other means of support may have to be devised.

X1.1.1.3 It has been shown that the amount of specimen support may affect the results obtained with this test method on a material's surface burning characteristics (see 1.3). It is the intent of this standard to provide the minimum amount of specimen support necessary to allow for a meaningful assessment of a material's surface burning characteristics.

X1.1.1.4 For some materials, portions of the test specimen may melt or otherwise drop from the mounting position. If all portions of the test specimen ahead of the flame front remain in position during the test, and do not sag to interfere with the burner flame, no additional supports are required, unless specified elsewhere in this test method or in a specific mandatory document the material must comply with.

X1.1.1.5 These suggested mounting methods are grouped according to building materials to be tested which are broadly described either by usage or by form of the material.

X1.1.2 Joints:

X1.1.2.1 Products that are normally installed adjoining themselves longitudinally are evaluated under this paragraph.

(a) Mounting methods should be considered for building products that normally incorporate joint details either in design or installation. A nonhomogenous product containing underlying core (Note X1.1) material that may adversely affect the test

results should be tested with a joint. This joint should be located longitudinally between the burners.

NOTE X1.1—Core is defined as: a central and often foundational part usually distinct from the enveloping part by a difference in nature (*Webster's New Collegiate Dictionary*).

(b) The surface burning behavior should be determined using the manufacturer's recommended joint detail.

(c) If a joint detail is not recommended by the manufacturer, the product should be tested both with a separation of $\frac{3}{16} \pm \frac{1}{16}$ in. (4.2 ± 1.5 mm) and with the edges in direct contact.

X1.2 Adhesives

X1.2.1 To determine the surface burning characteristics of adhesives, they shall be mixed as specified in the manufacturer's instructions and shall be applied to fiber-cement board in the thickness or at the coverage rate recommended by the manufacturer. The adhesive application shall be cured prior to testing.

X1.3 Plastics

X1.3.1 The term plastics includes foams, reinforced panels, laminates, grids, and transparent or translucent sheets.

X1.3.2 When any plastic will remain in position in the tunnel during a fire test, no additional support will be required. Thermoplastic and other plastics that will not remain in place are to be supported in accordance with Annex A4.

X1.4 Thin Membranes

X1.4.1 Single-layer membranes or thin laminates consisting of a limited number of similar or dissimilar layers not intended for adherence to another surface may be supported on poultry netting placed on steel rods in accordance with Annex A4. Netting shall be 20-gauge, 2-in. (51-mm) hexagonal galvanized steel poultry netting conforming to Specification A.190. If so tested, the specimen shall be additionally tested, bonded to a substrate representative of a field installation.

X2. DERIVATION OF FLAME SPREAD AREA FORMULAS APPEARING IN 9.1

X2.1 Introduction

X2.1.1 This appendix contains an abbreviated discussion of the derivations of the flame spread area formulas used to calculate the flame spread index in this test method. This appendix will show not only the derivations of the formulas, but will illustrate the relationship between this method of flame spread calculation and a previous method.

X2.1.2 In these calculations, it is assumed that the flame front never recedes. Hence, in Fig. 11 there is an imaginary line bounding the upper edge of area A_2 .

X2.2 Formula 1—Constant

X2.2.1 In Fig. X2.1, an idealized straight-line flame spread distance-time plot is drawn. Lines OA , OA' , and OA'' produce a family of areas ORA having a maximum possible area of 97.5 ft-min ($\frac{1}{2}$ by 10 min by 19.5 ft). These represent a steady progression of the flame front to a maximum distance at the end of the 10-min test.

X2.2.2 When the flame front spreads its maximum distance (19.5 ft) in 10 min, a formula used in Test Method E84 would yield the following FSI. See X2.5 for the origin of the value of 55 and for how the FSI values were derived prior to 1976:

$$FSI = \frac{550}{t} = \frac{550}{10} = 55 \quad (X2.1)$$

X2.2.3 Also, when the flame front is maximized at 19.5 ft in 10 min, the area in Fig. X2.1 ORA is maximized to 97.5 ft-min.

X2.2.4 To relate the current formula, which is of the straight line, origin intercept form, to the previous (Test Method E84) formula, it is necessary to equate the two as follows:

$$FSI = \frac{550}{t} = KA \quad (X2.2)$$

where:

K = proportionality constant for equations of the current formula's type, and

A_T = total area under area ORA .

If $A_T = 97.5$ ft-min at $t = 10$ min, then

$$FSI = \frac{550}{10} = K \times 97.5, \text{ and} \quad (X2.3)$$

$$K = \frac{550}{10 \times 97.5} = 0.564 \quad (X2.4)$$

X2.3 Formula 2—Constant

X2.3.1 In the idealized straight-line flame spread distance-time curve of Fig. X2.2, lines OI , OI' , and OI'' produce a family of trapezoidal areas $ORBI$ ranging from 97.5 to 195 ft-min ($\frac{1}{2}$ by 10 min by 19.5 ft to 10 min by 19.5 ft). This represents a flame front progression to the end of the specimen within the 10 min of the test. The area (A_T) of $ORBI$ may be expressed as follows:

$$\left(\frac{1}{2} \text{ by } 19.5 \text{ by } OR\right) + \left(\frac{1}{2} \text{ by } 19.5 \text{ by } (10 - At)\right) \quad (X2.5)$$

which is equal to:

$$195 - 9.75 At \quad (X2.6)$$

since OR is always 10 min.

X2.3.2 The triangular area OIA divided into a proportionality constant K will determine a relationship between flame spread indexes and the rate and distance of flame propagation. The total area available is 195 ft-min, hence area OIA is equal to $195 - ORBI$.

Thus, a new flame spread index formula may be derived as follows:

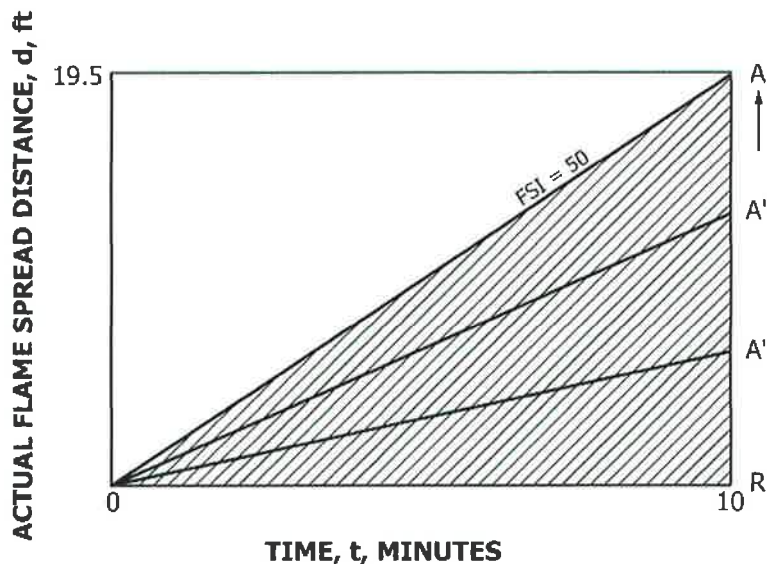

FIG. X2.1 Idealized Straight-Line Flame Spread Distance-Time Curve for Total Areas Less than or Equal to 97.5 min-ft

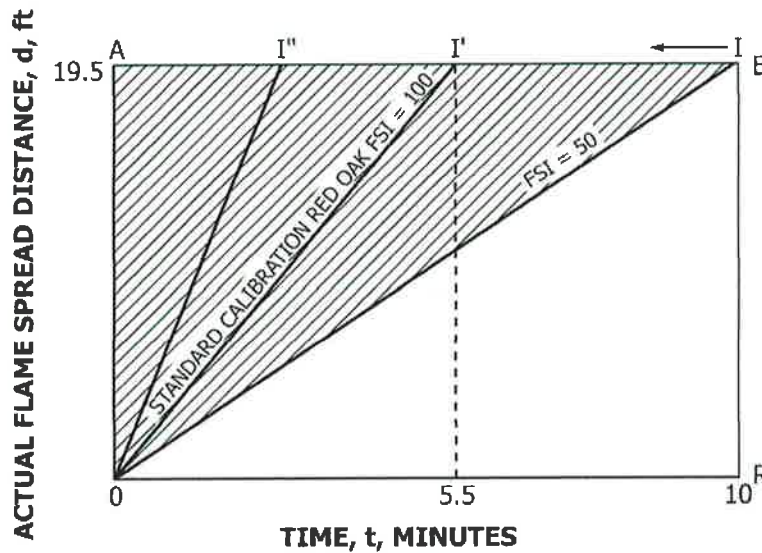

FIG. X2.2 Idealized Straight-Line Flame Spread Distance-Time Curve for Total Areas Greater than 97.5 min-ft

$$FSI = \frac{K}{OIA} = \frac{K}{195 - ORBI} = \frac{K}{195 - A_T} \quad (X2.7)$$

X2.3.3 To establish K , a relationship between the current and the previous Test Method E84 formulas will be established at the red oak calibration point of 19.5 ft progression at 5.5 min as follows:

$$FSI = \frac{550}{t} = \frac{K}{195 - A_T} \quad (X2.8)$$

where:

$$A_T = 195 - (9.75 (5.5)) = 141.38 \text{ ft-min, and } t = 5.5 \text{ min.}$$

Thus:

$$FSI = \frac{550}{5.5} = \frac{K}{195 - 141.38}, \text{ or} \quad (X2.9)$$

$$K = \frac{550 \times (53.63)}{5.5} = 5363$$

X2.4 Formulas 1 and 2

X2.4.1 To account for the disproportionate increase which can occur in FSI values at the lower end of the index scale, for $K = 0.564$ in Formula 1 and 5363 in Formula 2, a further mathematical modification is made.

X2.4.2 In order to establish a relationship between the constants (K) in X2.2 and X2.3, it is necessary to consider the form of the basic formulae, which are as follows:

$$FSI = \frac{K_1}{195 - A_T} \quad (A > K_2) \quad (X2.10)$$

$$FSI = K_3 A_T \quad (A < K_2)$$

where:

$$K_1 = 100 (195 - R),$$

R = the area associated under the curve that is to be associated with an index of 100,

K_2 = an arbitrary choice within the limits of 0 and 195, and $K_3 = K_1 / (K_2 [195 - K_2])$.

X2.4.3 Choosing $K_2 = 195/2$ produces a minimum value of K_3 , that is, any other K_2 value will result in a higher K_3 value, and choosing R , the area under a red oak calibration plot, as a median value of 146, implies the following:

$$K_1 = 100 (195 - 146) = 4900 \quad (X2.11)$$

X2.4.4 Then using 97.5 as the value for K_2 , K_3 would be:

$$K_3 = 4900 / (97.5 \times 97.5) = 0.515 \quad (X2.12)$$

X2.4.5 Thus, the formula for flame spread index in 9.1.3 is as follows:

$$FSI = 0.515 A_T \quad (X2.13)$$

X2.4.6 Thus, the formula for flame spread index in 9.1.4 is as follows:

$$FSI = \frac{4900}{195 - A_T} \quad (X2.14)$$

X2.5 The calculation method for FSI has undergone modifications over the years. It was first calculated as the ratio of the time taken for the flame to travel some distance along the tunnel length relative to that of red oak. In 1976, this calculation method was criticized because no account was taken for flame front recession in situations where the flame first advanced along the sample surface and then receded after a period of time. Therefore, the FSI calculation method was changed to a time-flame spread distance-area basis. The old method of calculating FSI was derived using a specified value of 100 for select-grade red oak flooring combined with the fact that, with select-grade red oak flooring, the flames took a time of 5.5 min to reach the end of the tunnel in a calibration test. If the flames reached the end of the tunnel before 5.5 min when testing a specimen, the FSI was deemed to be 550 divided by the time t in minutes. This explained how select-grade red oak flooring had an FSI of approximately 100 (1,3).

X3. GUIDE TO HANDLING MULTIPLE TEST DATA

X3.1 Introduction

X3.1.1 The following is a recommended procedure for average flame spread index and smoke developed index results:

X3.2 Flame Spread Index (FSI)

X3.2.1 Average the individual calculated flame-spread values determined in accordance with **9.1**, then round the average to the nearest multiple of 5 points. The rounded average is the FSI.

X3.3 Smoke Developed Index (SDI)-Average Smoke Value 200 or Under

X3.3.1 Average the individual calculated smoke developed values determined in accordance with **9.2**. If the average is 200

or lower, round the average to the nearest multiple of 5 points. The rounded average is considered the SDI.

X3.4 Smoke Developed Index (SDI)-Average Smoke Value Over 200

X3.4.1 Average the individual calculated smoke developed values determined in accordance with **9.2**. If the average is over 200, round the average to the nearest multiple of 50 points. The rounded average is the SDI.

X4. COMMENTARY

X4.1 Introduction

X4.1.1 This commentary has been prepared to provide the user of Test Method E84 with background information, including literature references, on the development and use of this test method. It also provides the reader and user with the basis for the methods that have been used for deriving numerical flame spread indexes; an appreciation of the variability of the test; and comments on its application and limitations for testing selected types of materials.

X4.1.2 On Nov. 28, 1942, 490 people died in a fire in the Boston Coconut Grove Nightclub. On June 5, 1946, 61 persons died in the La Salle Street Hotel fire. On Dec. 7, 1946, a fire in the Wincoff Hotel in Atlanta, Ga., claimed the lives of 119 persons. These fires had one thing in common. In all three fires, rapid flame spread along the surfaces of interior finish was judged to be a major factor in the spread of fire. Two had burlap wall coverings, and the other an early type of plywood which seriously delaminated. The fire protection authorities investigated several test methods with the objective of providing one that could be used to regulate interior finish materials and minimize repetition of such fires. These tests included: The Forest Products Laboratory Fire Tube Test (now Test Method **E69**); Federal Specification SS A118b (acoustical tile/bunsen burner test) (replaced by SS-A-118a-7/63-referencing Test Method E84); New York City Timber Test and Shavings Test (now obsolete); Crib Test-Specification C160 – 41 T (now Test Method **E160**); and The Swedish Schlyter Test. All of these were relatively small laboratory tests. Test Method E84 was developed on the premise that a large test would provide a more realistic and comprehensive test, and it has since been widely adopted for use by the building code authorities to regulate the use of interior finish materials. Subsequently during this same period, two other test methods were developed for use in research and development of new materials, the NBS Radiant Panel (Test Method **E163**) and the FPL 8-ft tunnel (Test Method **E286**). These test methods have been widely used for research and development purposes.

X4.2 History of Test Method E84

X4.2.1 The first “tunnel-type” furnace was built at Underwriters Laboratories around 1922 when “fire-proofing” paints and specifically “white wash” were actively promoted. The equipment consisted of a long bench with a noncombustible top. The sample consisted of a wood trough about 16 ft long, 18 in. wide, and 18 in. deep (5.568 m long, 0.522 m wide, and 0.522 m deep), placed upside down on the bench. The inside of the trough was coated with the paint. A known quantity of wood at one end furnished the ignition source.

X4.2.2 In 1927 and 1928, chemically impregnated wood was being developed, and Underwriters Laboratories, Inc., used a tunnel 36 in. wide, 23 ft long, and 13 in. deep (1.044 m wide, 8 m long, and 0.377 m deep) to evaluate its performance. It was during this time that red oak flooring was selected as a control to calibrate the furnace. The sample formed the top of the tunnel. The fuel and draft were also controlled.

X4.2.3 In the early 1940’s, a desire to reduce flammability of wood-based products, and the introduction of new building materials and combinations of materials brought about the need to further improve the tunnel. The development of the third tunnel furnace is explained fully in Underwriters Laboratories Bulletin of Research No. 32 (**1**).¹⁰ Subsequent refinements were incorporated, and the first formal test method was published as Standard U.L. 723 by Underwriters Laboratories in August 1950. Revised editions were published in 1958, 1960, 1971, 1977, and 1979. The National Fire Protection Association adopted the method as NFPA No. 255 in 1955 with revisions in 1958, 1961, 1966, 1970, 1972, and 1979. The test was adopted by the American Society for Testing and Materials as a tentative standard in 1950 and formally adopted in 1961 with revisions made in 1967, 1968, 1970, and from 1975 through 1980.

¹⁰ The boldface numbers in parentheses refer to the list of references at the end of this test method.

X4.2.4 The tunnel has been designated the “Steiner Tunnel” by Underwriters Laboratories in honor of Albert J. Steiner (4) who had spent much time developing this and many other fire test methods.

X4.2.5 Since 1950 the flame spread properties of materials, as measured by this method have been reported as ratings, classifications, or indices. The last is considered more indicative of the nature of the results and is the present terminology used in the standard. The original method of determining “flame spread index” was based on either the ratio of the time at which flames traveled the full tunnel length or the partial flame travel distance relative to that of red oak. In 1968, a change was made in the FSI calculation to account for an anomaly between results for flame spread greater than or less than 13½ ft. In 1976, the flame spread index was changed to an area basis. Here the total area under the distance-time curve, ignoring any flame-front recession, was compared to a prescribed area typical of red oak flooring. The current calculation method (see [Appendix X1](#)) uses a formula that takes the rate of flame travel into account.

X4.2.6 The sensitivity study by Endicott and Bowhay (5) in 1970 has led to a concerted effort by the “ASTM tunnel operators group” to address concerns identified by the report. Since 1975 a series of changes have been specified in the standard. These include defining duration of furnace preheating, the incorporation of a floor thermocouple, as well as more closely specifying details of furnace construction and standardization.

X4.2.7 Particular attention is being paid to the refinement of the apparatus and procedure involved in the measurement of the smoke generated during testing. Round-robin tests that have been conducted to date have indicated large differences in smoke developed values for interlaboratory tests on replicate specimens.

X4.2.8 Some of these revisions include standardization of the smoke-density measuring equipment, its location in the exhaust duct, and its orientation. The measurement of smoke density is reported in terms of the area under the light absorption time curve related to a similar curve for red oak. Since the quality of vision obscuring particles in the smoke column is not linearly related to light absorption, this procedure has been criticized by some parties. The method does however provide a basis for comparisons.

X4.2.9 In 1970, a revision to the scope was adopted to emphasize that there was no direct relationship between the flame spread index (FSI) and the fuel contributed or smoke density index (SDI). This revision was deemed necessary because some enforcement officials were assigning equal significance to the values.

X4.2.10 Prior to 1978, the report of tests included an evaluation of the fuel contribution as well as the FSI and SDI. However, it is now recognized that the rise in temperature of the thermocouple located near the end of the tunnel, on which it is based, does not provide a valid measure of fuel distribution. Therefore, although the data are recorded during the test, this information is no longer normally reported.

X4.2.11 [Appendix X1](#) adopted in 1968 is intended as a guide for the mounting of specimens. It is not a mandatory part of the method, since the intent of the method is that the specimen be tested as closely as possible to the manner in which it will be applied in general use. In 1978, revisions were made that dealt with the testing of adhesives, the description of a wood substrate for testing coatings, and the definition of the properties of the fiber-cement board used as a standard backing and the metal rods used as supports.

X4.3 Fire Exposure Conditions

X4.3.1 The tunnel test fire exposure is provided by a 4½-ft (1.35-m) long test flame, covering approximately 7 ft² (0.63 m²) of the 36 ft² (3.25 m²) of the exposed specimen surface during the 10-min test period. It releases heat at a rate of approximately 5000 Btu/min (88 kW) and creates gas temperatures near the specimen surface of up to 1600°F (900°C).

X4.3.2 The size and heat release rate of the exposing flame, developed after repeated experiment tests, although not optimum fire conditions, were selected to produce a flame spread over the entire length of the calibration material in about 5½ min (3). It was found that conditions could be changed so that flames would spread faster, but these conditions caused the flame to spread too fast to make the necessary observations of the flame spread, smoke density, and temperature rise of the thermocouple.

X4.4 Furnace Calibration

X4.4.1 Select red oak was chosen as a control material because this term denoted a fairly uniform grade of lumber nationally, whereas many other designations have a purely local significance. It is readily available, usually uniform in thickness and moisture content, and generally gives repetitive results. In recent years, experiments have been run using man-made materials such as particleboard in the hope of further refining the repeatability, however, red oak is still used as a calibrating material.

X4.4.2 The operating conditions of the tunnel are adjusted if necessary to ensure that the flame spreads to the end of the tunnel in 5.5 ± 0.25 min, for a specimen of red oak flooring. Tests are run with an inorganic fiber-cement board (ACB) specimen to establish the distance of the exposing flame at 4.5 ft. It should be noted that the calibration specifies only the time at which the flame passes over the end of the specimen. The FSI depends on the area under the flame spread versus the time curve. Therefore, the FSI of red oak is no longer exactly 100 as originally specified.

X4.4.3 Recognition of the importance of turbulence, including the role of fire bricks and of window recesses, resulted in a revision in the method in 1976 (see [5.1.3](#) and [5.1.7.2](#)).

X4.5 Repeatability and Reproducibility

X4.5.1 Four round-robin tests have been conducted: the first in 1959 sponsored by the former Acoustic Tile Assn. among four laboratories using four different tiles (6); the second in 1973 on floor coverings by the National Bureau of Standards with eleven cooperating laboratories (7); the third in 1978 on

loose-fill cellulosic insulation by the Consumer Product Safety Commission with six laboratories (10); the fourth in 1990 by ASTM Technical Committee E5 on Fire Standards with eleven participating laboratories(11).

X4.5.2 An ASTM task group of Subcommittee E05.22 composed of tunnel operators is now working on comprehensive design and on operational and procedural revisions to improve uniformity among facilities.

X4.6 Advantages and Problems

X4.6.1 Test Method E84 results have generally showed performance similar to that observed during accidental building fires for some materials and exposure. *It should be emphasized however that it is the intent of this test method to provide only comparative classifications.*

X4.6.1.1 It provides a large flaming fire exposure, with specimen thermal exposure and area coverage sufficient to bring about progressive surface burning and combustible volatile generation characteristic of the materials under evaluation resulting in a moving, wind-aided flame front.

X4.6.1.2 It involves a large specimen, nominally 36 ft² (3.25 m²) of exposed area, allowing for realistic fire involvement of material surfaces and the development of physical and structural failures (collapse, buckling, large ruptures or cracks, etc.) that may influence flammability performance during the test period.

X4.6.1.3 It may be applied to a wide range of materials, including composite constructions of faced or laminated boards, panels, units, or sections in actual field-installed thicknesses.

X4.6.1.4 It may be used to measure the effects of density, thickness, surface contour, surface finish, delamination, strength, and joint design on the surface flammability of the specimen.

X4.6.1.5 It does characterize most high-flame spread materials identified as having been involved in rapidly developing field fires (for example, highly combustible coatings on wood products, certain cellulosic acoustical materials, insulation facings applied with combustible adhesives, etc.), as well as providing an accurate characterization of the performance of some low flame-spread materials in actual fires (for example, gypsum and mineral products).

X4.6.1.6 Although this is a test to measure “surface burning characteristics,” the visual observation of flame travel is based on maximum flame extension anywhere within the tunnel volume, not necessarily directly on the specimen surface that may not be clearly visible. Surface flammability measurements of building materials do not yield a unique material property. Rather, the measurement is influenced by the method of test to a very considerable degree.

X4.6.1.7 Due to the fact that the smoke measurement photometer system is oriented vertically, the potential exists for the accumulation of soot or dust, or both, on the photoelectric cell during the test, thereby causing erroneous smoke measurements. The laboratory should be aware of this possibility and implement procedures and practices to prevent or mitigate such occurrences.

X4.7 Uses and Limitations

X4.7.1 The orientation of the specimen in this method is in a horizontal ceiling position. This orientation places some limitations on the type of material that can be realistically mounted during testing. Prior to 1960, the tunnel was used primarily for the investigation of the surface burning characteristics of homogeneous compositions of ceiling and wall finishes, such as acoustical tiles, wall coverings, coatings, and various types of decorative panel, all being able to support themselves in the ceiling position throughout the test.

X4.7.2 Through adaptation ([Appendix XI](#) on Guide to Mounting Methods added in 1968), the procedure was expanded to include the evaluation of composites and assemblies. The guide contains mounting suggestions for a number of individual categories of product classifications, including: acoustical and similar panel products; composite building units; adhesives, batt- and blanket-insulating materials; fire-retardant and general-purpose coatings; loose-fill thermal insulations; treated and untreated plywoods; lumber and wood composition boards; foamed, molded, reinforced, and laminated plastics; and sheet-type wall coverings.

X4.7.3 The difficulty of defining materials that contribute little or no fuel to a fire has in the past led to the use of Test Method E84 to provide information about the combustibility of materials. ASTM Committee E5 does not and has not ever recommended that the results of these tests be used alone to describe material combustibility.

X4.7.4 Composite assemblies or panels using metal or mineral facings and combustible interior cores, and which remain essentially impermeable to flame throughout the test period, may not be completely evaluated for surface burning behavior by this method, since the interior cores are not fully challenged.

X4.7.5 Some materials require support to remain in place during the test period, such as loose-fill insulation supported by a metal screen. The supporting screen tends to provide low flame spread indices (FSI) relative to those obtained for materials that are not so supported. Conversely, materials that are supported on rods, such as batt insulation may produce higher FSI if retained on the ceiling rather than allowed to burn on the floor.

X4.7.6 Some materials, such as composites may delaminate during the test. This may cause two possible responses, the material may expose two or more surfaces to the flame increasing the FSI; the material may sag or drop one end into the fire chamber impeding further flame spread.

X4.7.7 Some materials, such as cellular plastics and thermoplastic materials, can be difficult to evaluate. Thermoplastic materials not mechanically fastened will often fall to the floor of the tunnel. Accordingly, these materials as well as thermosetting cellular plastics can also receive relatively low FSI (10,11). If supported on wire screen, rods or other supports, some plastic materials can be completely engulfed in flame, and a questionable comparison would result between the flame spread indices and smoke developed indices of these materials and those of materials that are unsupported.

X4.7.8 The materials described above, that is, those that drip, melt, delaminate, draw away from the fire, or require artificial support present unique problems and require careful interpretation of the test results. Some of these materials that are assigned a low FSI based on this method may exhibit an increasing propensity for generating flame-over conditions during room fire test with increasing area of exposure of the material and increasing intensity of the fire exposure. The result, therefore, may not be indicative of their performance if evaluated under large-scale test procedures. Alternative means of testing may be necessary to fully evaluate some of these materials.

X4.7.9 In order to provide needed technical data, flammability evaluations of cellular plastics for building construction using the Steiner tunnel began with the testing and classification of a flame-retardant formulation of polystyrene foam board in 1960, with subsequent evaluation of polyurethane-type boards incorporating flame-retardant resin systems (first generation) beginning in 1964, polymerically and chemically modified flame retardant polyurethane type formulations (second generation) in 1965, polyisocyanurate-type foams initiated in 1968 and, most recently, urea-formaldehyde type, cavity-fill

foams. Spray-applied and poured-in-place cellular foam systems were first subjected to the test in 1968 and 1972, respectively.

X4.7.10 From 1960 through 1973, in excess of 2000 tunnel tests have been conducted on flame retardant and general-purpose polystyrene, polyurethane, polyisocyanurate and urea-formaldehyde cellular plastics, in board-stock, spray-applied or pour-in-place foams, yielding flame spread values ranging from less than 5 to over 2000.

X4.7.11 The flame spread index of some materials may vary depending upon environmental conditions. The prescribed limits on the temperature and relative humidity for specimen conditioning and tunnel air supply were selected to minimize these effects.

X4.8 Correlation with Other Fire Conditions

X4.8.1 Several studies have been made to examine the relationship of the FSI test results on materials with their performance in large scale fire growth experiments and with their performance in other laboratory test methods. Some of these comparisons are given in Refs (11, 12, 13, 14, 15)

X5. SPECIFIC TEST METHODS AND APPLICATION STANDARDS

X5.1 The following standards address testing of materials in accordance with test methods that are applications or variations of this test method or apparatus.

X5.1.1 Wires and cables for use in air-handling spaces are covered by NFPA 262.

X5.1.2 Pneumatic tubing for control systems are covered by UL 1820.

X5.1.3 Combustible sprinkler piping is covered by UL 1887.

X5.1.4 Optical fiber and communications raceways are covered by UL 2024.

X5.1.5 Materials required to meet the extended Test Method E84 to a 30-min duration are covered by Test Method 1.2768.

REFERENCES

- (1) Bijelic, N., "Commissioning of a Modular Steiner Tunnel", (PhD thesis, University of Waterloo, 2015).
- (2) Abrams, M. Souza, V. D., Higginson, P. Metes, W. S., Quintiere, J. G., Parker, J., Robins, R. F., White, J. A., Abrams, R., and Souza, D., "Review of ASTM Test for Surface Burning Characteristics of Building Materials(E 84) (An ASTM White Paper)," *Journal of Testing and Evaluation* 132, 89–114, March 1985.
- (3) Underwriters Laboratories, Inc., "Fire Hazard Classification of Building Materials," *Bulletin of Research*, No. 32, Chicago, IL, September 1947.
- (4) Steiner, A. J., *Building Officials Conference of America Yearbook*, 1949–1950, pp. 115–116.
- (5) Endicott, L. E. and Bowhay, R. B., "A Statistical Evaluation of the Fire Hazard Classification Furnace (ASTM E84 – 68)," *ASTM Materials Research and Standards*, May 1970, pp. 19–21, 50–52.
- (6) "Round Robin Tests on Tunnel Type Flame Spread Furnaces" for ASTM Project No. 1–811–2, Final Report, Southwest Research Institute, San Antonio, TX, April 16, 1959.
- (7) Lee, T. G. and Huggett, C., "Interlaboratory Evaluation of the ASTM E84 – 70 Tunnel Test Applied to Floor Coverings," *Journal of Testing and Evaluation*, Vol 3, No. 1, ASTM, 1975.
- (8) Lawson, J. R., "An Interlaboratory Evaluation of the ASTM E84–74a Tunnel Test Modified by the Consumer Products Safety Commission for Cellulosic Loose Fill Insulation, NBSIR 79-1922, November 1979.
- (9) ASTM, "Interlaboratory Study to Establish Precision Statements for ASTM E84, Standard Test Method for Surface Burning Characteristics of Building Materials, ISR #E05-0001, November 1994.
- (10) Williamson, R. B. and Baron, F. M., "A Corner Test to Simulate Residential Fires," *Journal of Fire and Flammability*, Vol 4, April 1973, pp. 99–105.
- (11) D'Souza, M. V. and McGuire, G. H., "ASTM E84 and the Flammability of Thermosetting Plastics," *Fire Technology*, Vol 13, No. 2, May 1977, pp. 83–94.
- (12) Waterman, T. E., "Relation of the Building Occupancy and Design to Use of Combustible Materials on Construction," IITRI Report, *Society of Plastics Industry, Inc.*, IIT Research Institute, Chicago, IL, October 1968.
- (13) Underwriters Laboratories, Inc., *Flammability Studies of Cellular Plastics and Other Building Materials Used for Interior Finish*, Subject 723, U.L., Inc., Northbrook, IL, June 13, 1975.
- (14) McGuire, J. H., "The Spread of Fire in Corridors," *Fire Technology*,

Vol 4, No. 2, May 1968, pp. 103–108.

(15) Laymon, R., Gandhi, P. and Liu, X., “Combustibility of Interior Finish and Building Materials Using Small-Scale, Steiner Tunnel

and Room-Corner Tests,” in Proceedings 11th International Conference, Fire and Materials, January 29-31, 2007, San Francisco, CA, Publisher: Interscience Communications, London, UK.

SUMMARY OF CHANGES

Committee E05 has identified the location of selected changes to this standard since the last issue (E84-18a) that may impact the use of this standard. (Approved Oct. 1, 2018.)

(1) Former appendix sections on acoustical and other similar panel products less than 20 in.; coating materials, cementitious mixtures, and sprayed fibers; and loose-fill insulation were converted to **Annex A8**, **Annex A9**, and **Annex A10**.

Committee E05 has identified the location of selected changes to this standard since the last issue (E84-18) that may impact the use of this standard. (Approved July 1, 2018.)

(1) The last sentence in **A4.8.1** and **A4.9.1** was added. (2) The words “on center” were added in **A4.8** and **A4.9**.

Committee E05 has identified the location of selected changes to this standard since the last issue (E84-17a) that may impact the use of this standard. (Approved March 1, 2018.)

(1) The appendix section on textiles was converted into **Annex A6**. (2) The appendix section on Batt or Blanket-Type Insulating Materials was converted into **Annex A7**.

Committee E05 has identified the location of selected changes to this standard since the last issue (E84-17) that may impact the use of this standard. (Approved Nov. 1, 2017.)

(1) **Annex A4** was revised.
 (2) Old Appendix X1.3 on Caulks and Sealants was removed and reference to Practice **E2690** in **6.8** was revised.

Committee E05 has identified the location of selected changes to this standard since the last issue (E84-16) that may impact the use of this standard. (Approved Aug. 1, 2017.)

(1) Paragraphs **6.8** and **11.1.3.3** were revised. (4) Old paragraphs X1.1.2.1, X1.1.2.2 and X1.1.2.3 were deleted.
 (2) **Annex A4** and **Annex A5** were added.
 (3) **Annex A3** was revised.

ASTM International takes no position respecting the validity of any patent rights asserted in connection with any item mentioned in this standard. Users of this standard are expressly advised that determination of the validity of any such patent rights, and the risk of infringement of such rights, are entirely their own responsibility.

This standard is subject to revision at any time by the responsible technical committee and must be reviewed every five years and if not revised, either reapproved or withdrawn. Your comments are invited either for revision of this standard or for additional standards and should be addressed to ASTM International Headquarters. Your comments will receive careful consideration at a meeting of the responsible technical committee, which you may attend. If you feel that your comments have not received a fair hearing you should make your views known to the ASTM Committee on Standards, at the address shown below.

This standard is copyrighted by ASTM International, 100 Barr Harbor Drive, PO Box C700, West Conshohocken, PA 19428-2959, United States. Individual reprints (single or multiple copies) of this standard may be obtained by contacting ASTM at the above address or at 610-832-9585 (phone), 610-832-9555 (fax), or service@astm.org (e-mail); or through the ASTM website (www.astm.org). Permission rights to photocopy the standard may also be secured from the Copyright Clearance Center, 222 Rosewood Drive, Danvers, MA 01923, Tel: (978) 646-2600; http://www.copyright.com/